

Article number: 20818518

Description: E+G Collar nut
DIN 6331-M36

Measures

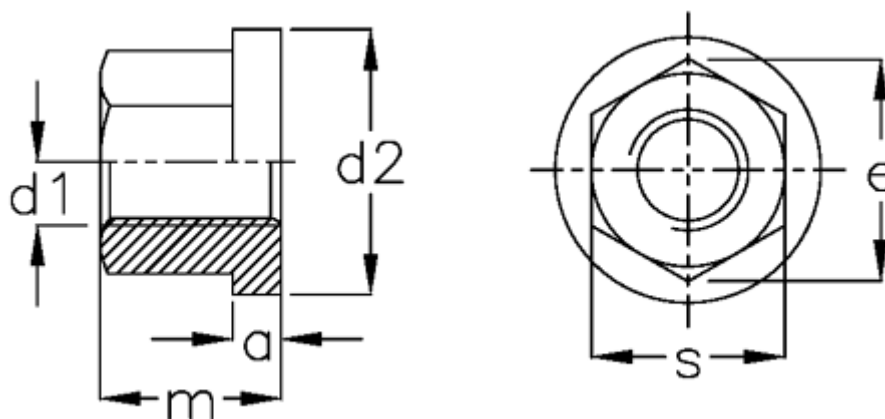

a = 10.0

d1 = M36

d2 = 68

e = 63.5

m = 54

s = 55